



Air purifier

Floor standing or desktop type

Model  
MC55YPVM

# Air Purifier OPERATION MANUAL



- Thank you for purchasing this air purifier.
- Please read the operation manual carefully and follow it for correct use.
- **Please read the “Safety Precautions” section before use.** [▶Page 3, 4](#)  
Please keep the operation manual in a safe place for later reference.



# Features

## Streamer Technology



This technology employs a “streamer discharge”, a type of plasma discharge comprising high-speed electrons with powerful oxidative capacity, that is generated inside the air purifier. The discharge swiftly removes odours. (The high-speed electrons are generated and then adsorbed within the unit to ensure your safety.)

**Streamer discharge decomposes adsorbed odour.**

- Decomposition cycle that maintains deodorising capacity.

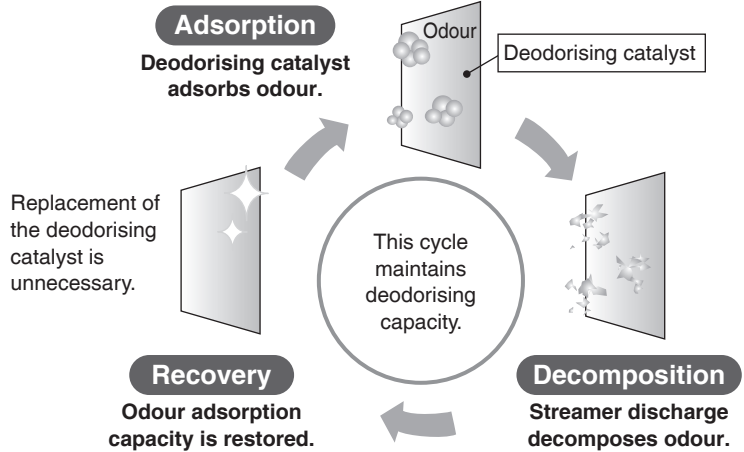

Streamer operation is conditional on the degree of air impurity.

During operation, the streamer discharge may generate a hissing sound, however, this does not indicate a defect.

In addition, the sound may lessen or change in tone depending on the operating environment, however, such changes are normal.

In some cases the air outlet may emit a slight odour as trace amounts of ozone are generated. However, the amount is negligible and is not harmful to your health.

## Active plasma ion technology

- **Increases skin moisture content**

Evaluation method: Skin moisture content of 8 healthy women with sensitivity to skin dryness was measured in approx. 10m<sup>2</sup> room in the presence and absence of active plasma ion generation

Measurement agency: Soiken, Inc.

Test number: MII-2010-10

Results: Skin moisture content increased 1.8 times over approx. 120 minutes

- Actual effects vary by operating environment and usage patterns.

## Controlling PM2.5

These results were obtained in a 32m<sup>3</sup> airtight space. They are not demonstrable effects in customer environments.

### Elimination of 99% of 0.1-2.5µm particles (\*1).

- Does not take into account inflow of new particles from outdoors owing to ventilation etc.
  - PM2.5 is a generic term for particulate matter that is 2.5µm or less in size.
  - Elimination of particulate matter that is less than 0.1µm in size by this air purifier has not been verified.
- This product cannot eliminate all airborne toxic substances.

(\*1) Test methodology: The Japan Electrical Manufacturers' Association standard (JEM1467)

Decision criteria: Elimination of 99% of 0.1-2.5µm particulate matter in a 32m<sup>3</sup> airtight space in 90 minutes or less. Equivalent value for 32m<sup>3</sup> test space.

## Powerful and swift suction action driven by large airflow

Suction of house dust and odours with large airflow.

3 filter layer structure ensures thorough and rapid purification of the ambient air.

### Substances that can be controlled/broken down

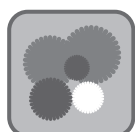

Mould



Pollen



Allergens such as dust mite droppings and remains



Odours



Formaldehyde



Diesel particulate matter



NOx



Dust



Yellow sand

### Substances that can be trapped

# Contents

## Read First

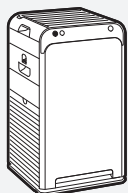

Features .....	1
Safety Precautions .....	3
Names of Parts and Operations .....	5
Preparation Before Operation.....	8

## Operation

Using the Air Purifying Operation .....	10
Changing the Airflow Rate .....	10

## Useful Functions

Operating the Unit in a MODE .....	11
AUTO FAN / ECONO / ANTI-POLLEN	
Using the Child Proof Lock .....	13
Adjusting Indicator Lamp Brightness .....	13

## Advanced Settings

Streamer Output Settings .....	14
Active Plasma Ion Output Settings .....	14
Setting Dust/PM2.5 Sensor Sensitivity .....	15
Settings of Modes within ECONO MODE .....	16

## Maintenance

Maintenance .....	17
Replacing the Streamer Unit .....	19
Separately Sold Parts / When Not Using the Unit for Long Time Periods .....	20



## Troubleshooting

About the Indicator Lamps .....	21
FAQs .....	22
Troubleshooting .....	23
Specifications .....	26

# Safety Precautions

■ Observe these precautions in order to prevent property damage or injury.

■ The consequences of incorrect use are categorised as follows.



 <b>WARNING</b>	 <b>CAUTION</b>
Failure to follow these instructions properly may result in personal injury or loss of life.	Failure to follow these instructions properly may result in property damage or personal injury, which may be serious depending on the circumstances.

■ Precautions to be observed are categorised using symbols.

 Never attempt.	 Be sure to follow the instructions.
--	---

 **WARNING** Observe in order to prevent fires, electric shocks or severe injury.

■ Concerning the power supply plug and cord

-  • **Do not unplug while the unit is in operation.** (Fire or an electric shock may result from heating)
-  • **Do not plug or unplug with wet hands.** (An electric shock may result)
- **Do not use in such a way that the ratings of the power socket or wiring appliances are exceeded or use a voltage outside of the range AC220-240V.**  
(Fire may result from heating if the ratings of multi-socket power adapters, etc., are exceeded)
- **Do not pull on the power supply cord when unplugging.** (Heating or fire may result from wire breakage)
- **Do not subject to acts that might damage them.**  
–Such acts include damaging, modifying, forcibly bending, pulling, twisting, bundling up, placing heavy objects on, etc., the power supply plug or cord. If the power supply plug or cord is damaged, it must be replaced by the manufacturer, its service agent, or a similar qualified person in order to avoid a hazard.  
(An electric shock, short circuiting, or fire may result from use while damaged)
-  • **Insert the power supply plug firmly all the way in.**  
–Do not use a damaged power supply plug or a loosely fitted power socket.  
(An electric shock or fire, due to heating or short circuiting, may result if the power supply plug is not firmly inserted)
- **Periodically wipe dust off the power supply plug with a dry cloth.**  
–If the unit is not to be used for an extended period of time, unplug the power supply plug.  
(Fire or overheating may be caused by defective insulation resulting from moisture etc.)
- **When performing maintenance, inspecting, or moving the unit, make sure to turn off and unplug the appliance.** (An electric shock or injury could result)

■ Do not use in the following places

-  • **Places where oil or flammable gases are used or may leak.** (Fire or smoke may result from ignition or suction toward the unit, or injury may result from degradation or cracking of plastic)
- **Places where there is corrosive gas or metal dust particles.**  
(Fire or smoke may result from ignition or suction toward the unit)
- **Places where temperature and humidity levels are high or water may scatter, such as a bathroom.** (Fire or an electric shock may result from electrical leakage)
- **Places accessible to small children.** (An electric shock or injury may result)

■ During use

-  • **Do not use chlorinated or acidic detergents.** (Injury may result from the degradation or cracking of plastic, or harm may be caused to health from the production of toxic gases)
- **Keep burning cigarettes or incense sticks away from the unit.**  
(Fire or smoke may result from ignition or suction toward the unit)
- **Do not attempt to disassemble, reconstruct or repair the unit yourself.**  
(Fire, an electric shock, or injury may result) For repairs, please contact the place of purchase.
- **Do not insert fingers, sticks, or any other item, into the air inlets or air outlet.**  
(An electric shock, injury, or damage may result)
- **Do not pour water on to the air outlet or the unit.** (Fire or an electric shock may result)
- **Do not use flammable substances (hair spray, insecticide, etc.) near the unit.**  
**Do not wipe the unit with benzine or thinner.** (An electric shock, fire, or cracking may result)

**⚠ WARNING** Observe in order to prevent fires, electric shocks or severe injury.

■ **Concerning the remote controller**

- ⊘ **Do not place the remote controller in places where small children can reach.**  
(Bodily harm may result from misoperation of the unit or accidental ingestion of the batteries)
- **Make sure not to insert the batteries in the wrong polarity (+/-) orientation.**  
(Short circuiting, fire, or battery leakage may result)

■ **Immediately turn off and unplug the unit if there are any signs of abnormality or damage**

**! Examples of abnormality or damage**

- The unit does not operate even if the switch is turned on.
- Current passes through the cord only sometimes if the cord is moved.
- There are abnormal sounds or vibrations during operation.
- The casing of the unit has deformed or is abnormally hot.
- There is a burnt smell. (Malfunctioning, an electric shock, smoke, fire, etc., may result if the abnormality is not addressed and the unit continues to be used)

Contact the place of purchase.

**⚠ CAUTION** Observe in order to prevent short circuiting, injury or property damage.

■ **During use**

- ⊘ **Small children or immobile persons (due to illness or injury) should not operate the unit by themselves.**

◆ **For EU:**

This appliance can be used by children aged from 8 years and above and persons with reduced physical, sensory or mental capabilities or lack of experience and knowledge if they have been given supervision or instruction concerning use of the appliance in a safe way and understand the hazards involved.

Children shall not play with the appliance. Cleaning and user maintenance shall not be made by children without supervision.

◆ **For other than EU:**

This appliance is not intended for use by persons (including children) with reduced physical, sensory or mental capabilities, or lack of experience and knowledge, unless they have been given supervision or instruction concerning use of the appliance by a person responsible for their safety.

– Children should be supervised to ensure that they do not play with the appliance.

– Persons who are heavily intoxicated or have taken sleep medication should not operate the unit.

(An electric shock, injury or poor health may result)

- **Do not use products, such as cosmetics, that contain fine powder, near the unit.**

(An electric shock or malfunctioning may result)

- **Do not operate the unit when fumigating insecticide is in use.**

– After using insecticide, make sure to sufficiently ventilate the room before operating the unit.

(Harm may be caused to health from an outflow of accumulated chemical compounds from the outlet)

- **Do not use near a smoke detector.**

– If out flowing air flows in the direction of a smoke detector, the response of the smoke detector may be delayed or it may fail to detect smoke.

- ! Frequently ventilate the room when using the unit together with combustion-based heating devices.**

– Usage of this product is not a substitute for ventilation. (Potential cause of carbon monoxide poisoning)

This product cannot eliminate carbon monoxide.

- **If the unit is placed within reach of a pet, be careful that the pet does not urinate on the unit or chew on the power supply cord.** (Fire, an electric shock, or injury may result)

■ **Concerning the unit body**

- ⊘ **Do not obstruct the air inlets or air outlet with laundry, cloth, curtains, etc.**  
(Overheating or fire may result from poor circulation)
- **Do not climb, sit or lean on the unit.** (Injury may result from falling or toppling)

■ **When moving the unit**

- ! When picking up the unit to move it, handle the unit with caution.**  
– Make sure to always hold the unit using the correct grips. Do not hold the unit using the grip on the deodorising filter unit. (Injury may result from falling)

# Names of Parts and Operations

## ⚠ CAUTION

Do not lift up the unit holding the grip on the deodorising filter unit. (May lead to falling over)

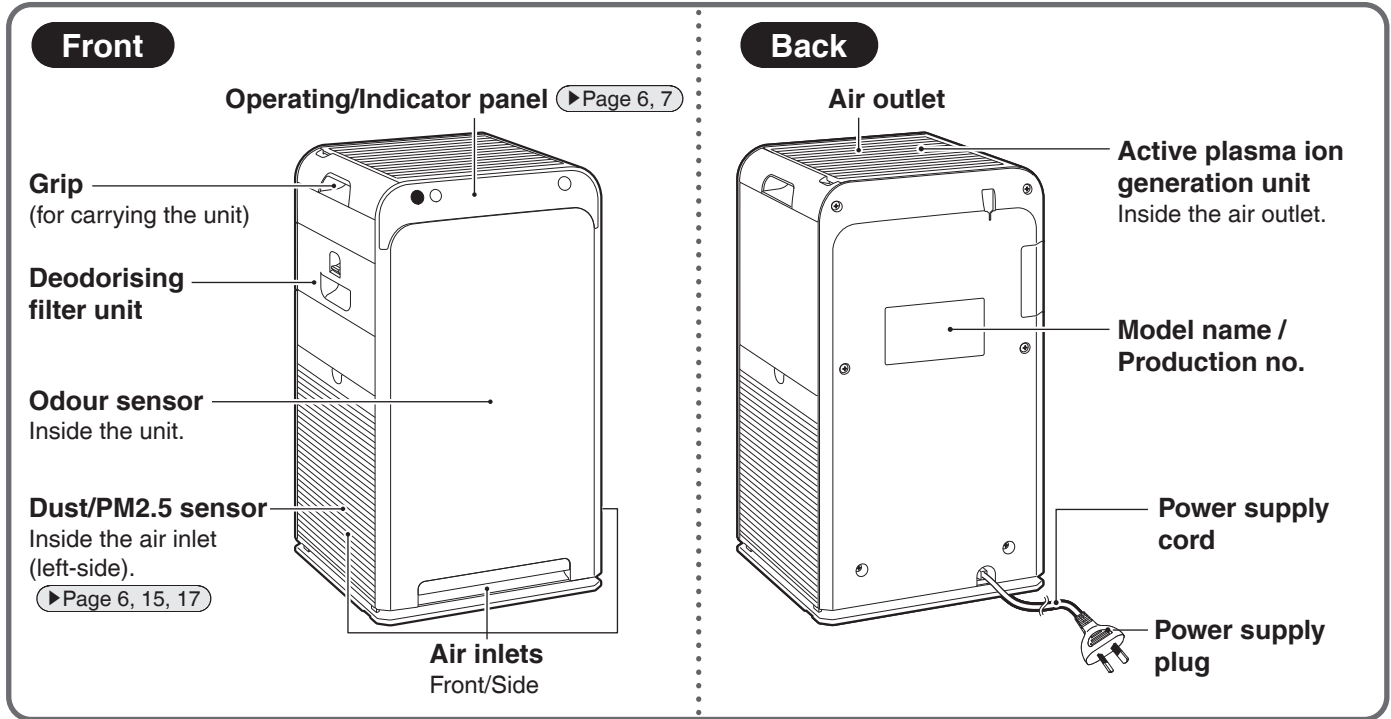

## Main Removable Parts

### Attention

To prevent malfunctioning, make sure to only operate the unit with all parts attached.

### Front

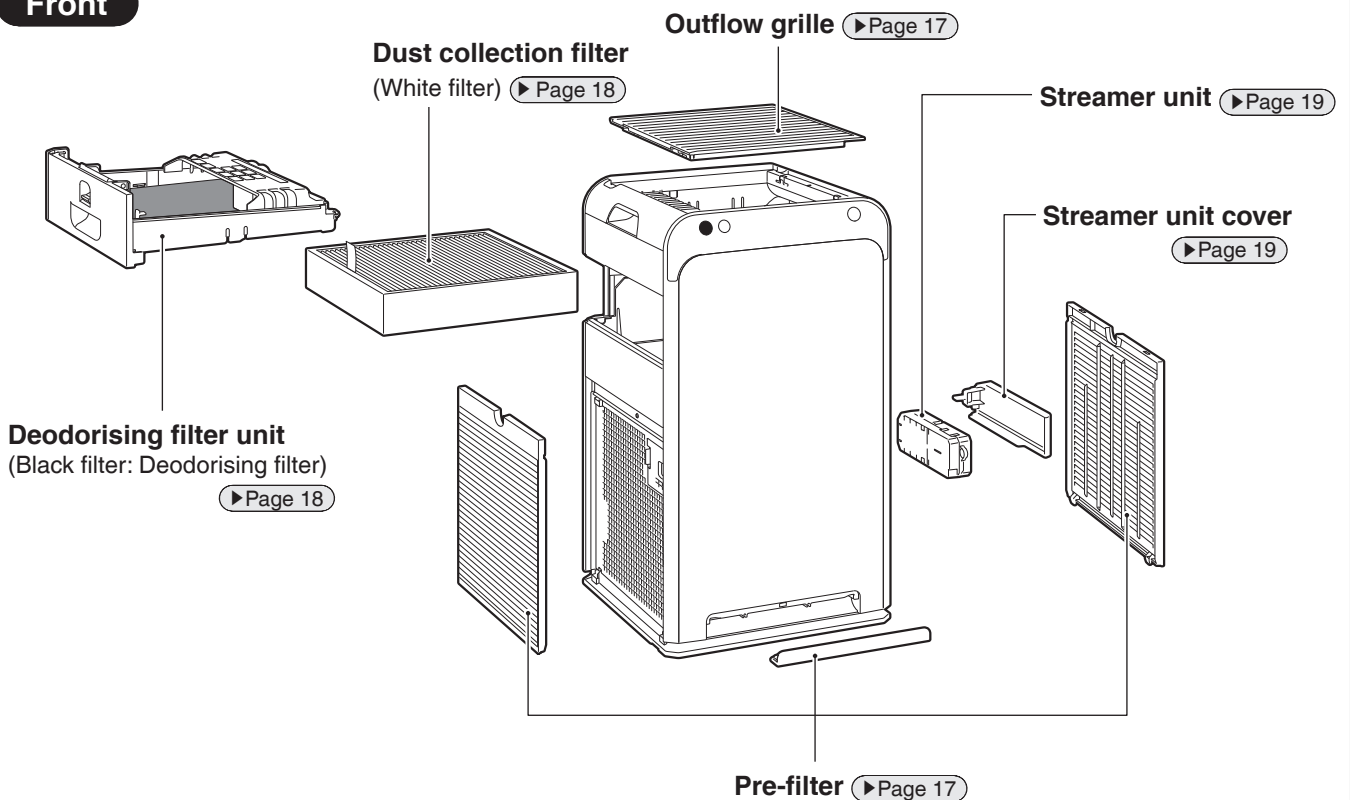

**Operating/Indicator panel**

When a lamp is blinking ▶Page 21

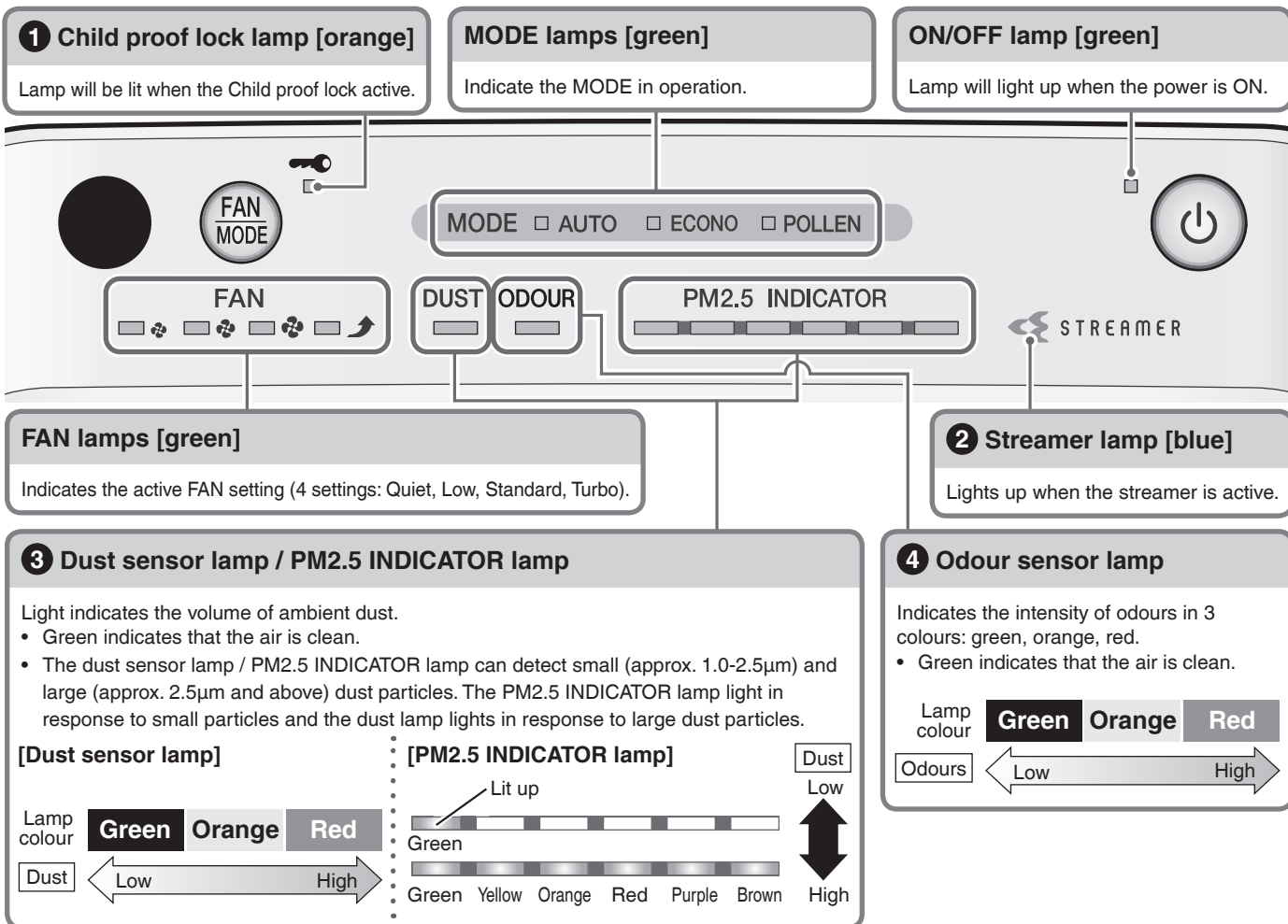

**1 About the child proof lock lamp** .....

• When lit up, operations will be restricted. When buttons are pressed, only a tone (3 short beeps) will sound, preventing misoperation by small children. ▶Page 13

**2 About the streamer lamp** .....

• This lamp lights up when the streamer is operating. The streamer operates depending on the degree of air impurity.  
 • If the hissing sound generated by the streamer discharge or the smell of ozone bother you, set streamer output to low. ▶Page 14

**3 About the dust sensor lamp / PM2.5 INDICATOR lamp** .....

• After operation is started, the lamp will light green for the first minute (approx.) regardless of air impurity level.  
 • The responsiveness of the dust/PM2.5 sensor may be poor during FAN setting "Turbo" or when airflow is high in AUTO FAN MODE. The strong airflow causes dust to be drawn into the air inlets before it can be detected by the dust/PM2.5 sensor. This is normal (not a malfunction).  
 • If the responsiveness of the dust/PM2.5 sensor is poor, change the sensitivity setting of the sensor. ▶Page 15

**Dust/PM2.5 sensor detection range**

Detectable matter
house dust, tobacco smoke, pollen, mites, pet hairs, diesel particulate matter
Sometimes detectable
steam, oil smoke

**4 About the odour sensor lamp** .....

• If operation is started immediately after the power supply plug is inserted, the lamp will light green for the first minute (approx.).  
 • If odour intensity levels are unchanging, the sensor may not respond even if there is a strong odour in the air.  
 • The sensor may not respond to some odours such as pet odours (excluding ammonia), garlic odour, etc.  
 • As odour perception varies by person, in some cases an odour may be sensed even when the lamp is green.  
 If the odour bothers you, switch to manual airflow rate, and select a high airflow rate. ▶Page 10

**Odour sensor detection range**

Detectable matter
tobacco odours, cooking odours, pet odours, toilet smells, waste smells, mould odours, sprays, alcohol
Sometimes detectable
sudden changes in temperature/humidity, steam, oil smoke, gas emitted from combustion-based heating devices

The ambient odour level in the first minute after the unit is plugged in serves as the reference level upon which the sensitivity of the odour sensor is determined. Insert the power supply plug when the air is clean (odour-free).

# Names of Parts and Operations

## Operating/Indicator panel

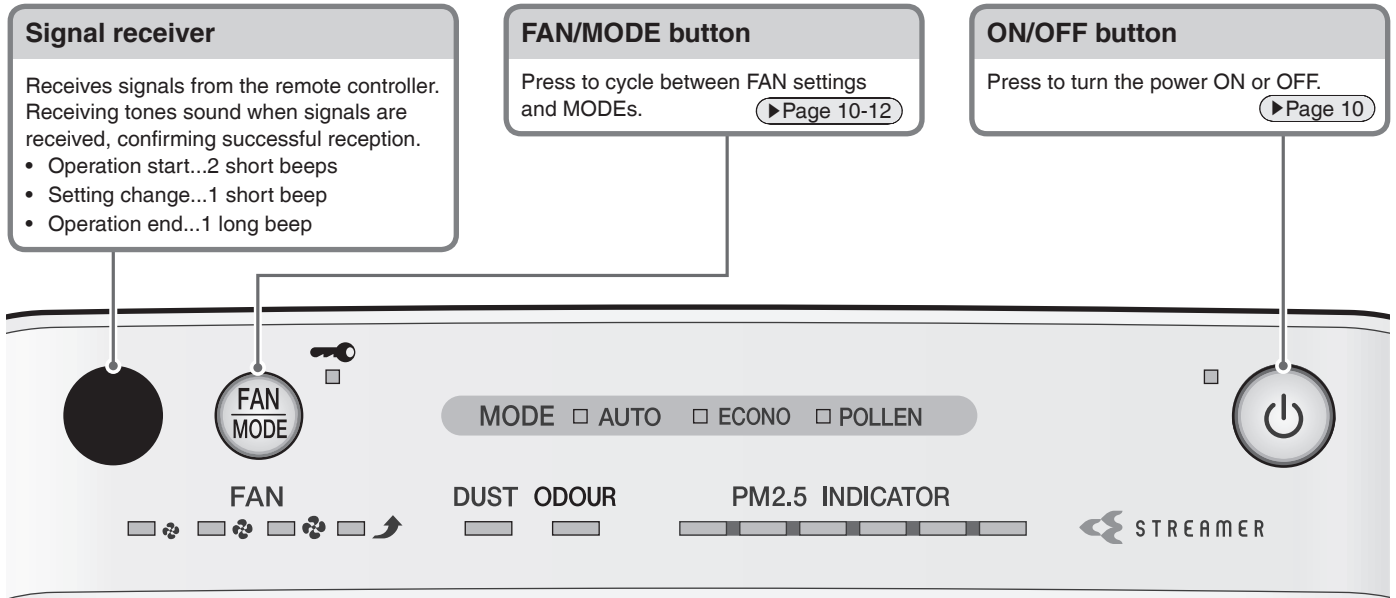

## Remote controller

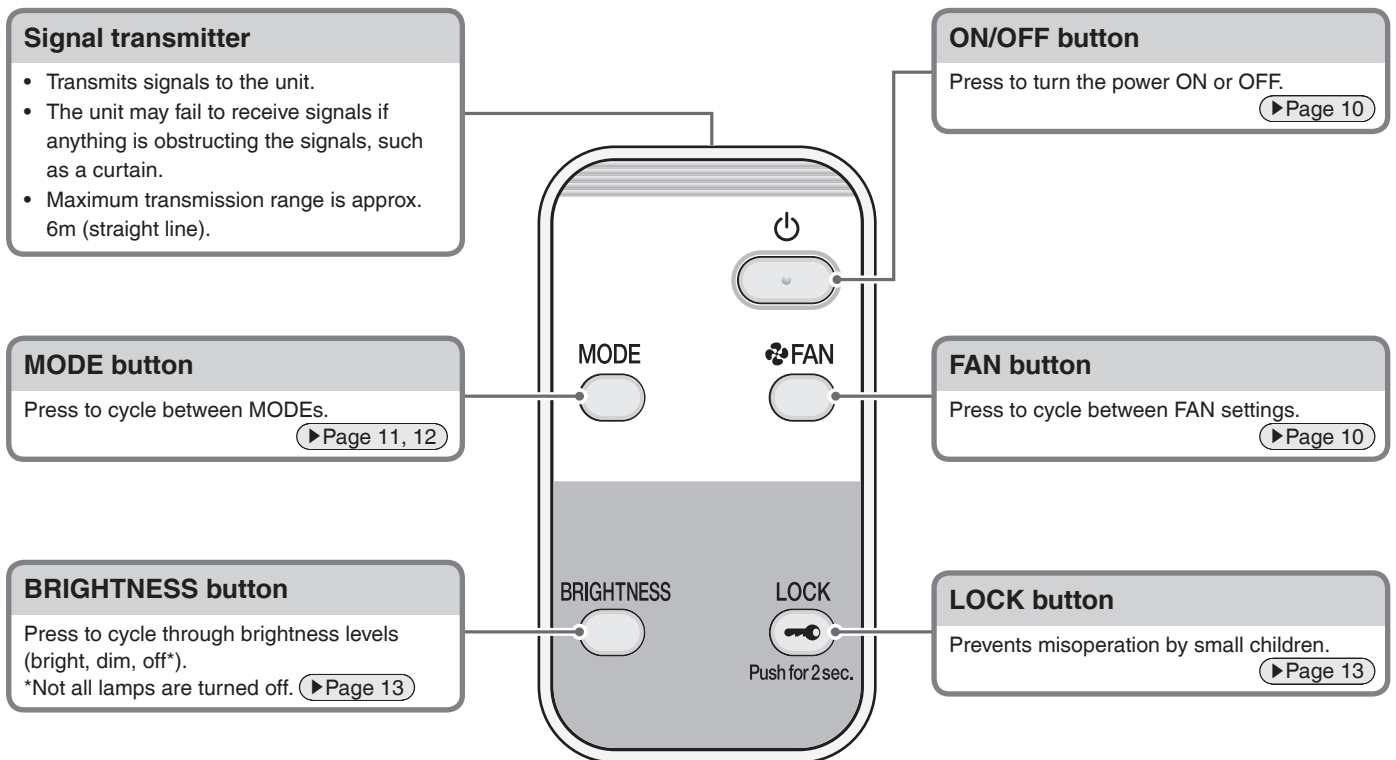

## Accessories



Operation manual ..... 1



Remote controller ..... 1



Remote controller holder ..... 1



# Preparation Before Operation

## 1 Positioning the unit

Before installation, peel off the tape fixing the power supply cord to the bottom of the unit and draw out the power supply cord.

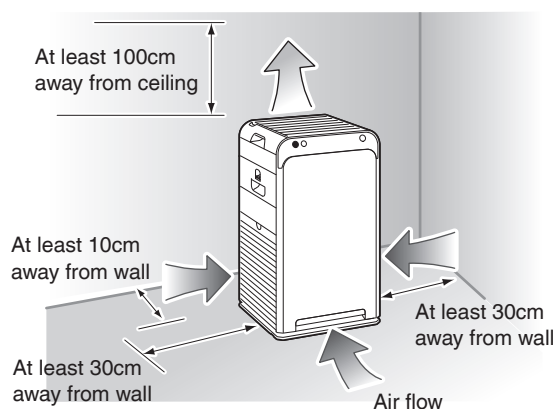
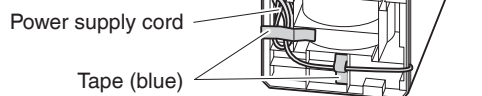

### Pointers for good positioning

- Choose a position from where airflow can reach all areas of the room.
- Place on a stable surface. If the unit is placed on an unstable surface, vibrations from the unit may be amplified.
- If you find that interference from the power circuit inside the unit or cables causes interference on your TV screen or static noise to be emitted from nearby radios or stereos, move the unit to at least 2m away from the device. Keep cordless phones and radio-controlled clocks away from the unit also.

### Attention

- To avoid staining of walls, position the unit in accordance with the positioning measurements in the illustration. However, note that since this unit draws in dirty air, certain types of wall may be stained even if the measurements are adhered to. In such cases, make sure to maintain sufficient distance between the unit and the wall.
- When used for a long period of time in the same location, the floor and surrounding walls may get stained as air is drawn into air inlets near the base of the unit. It is recommended to clean the unit periodically.

## Do not use in the following places

- **Places exposed to direct sunlight**  
(Decline in the receptivity of the remote controller signal receiver or discolouration may result)
- **Positions near combustion-based heating and other high temperature devices**  
(Discolouration or deformation may result)
- **Places where chemicals and pharmaceuticals are used such as hospitals, factories, laboratories, beauty salons, and photographic laboratories**  
(Volatilised chemicals and solvents may degrade mechanical parts and lead to malfunction)
- **Places with high levels of electromagnetic waves such as near an electromagnetic cooker, speakers, etc.**  
The unit may not function correctly.
- **Places exposed to soot (conductive dust) released by candles, aromatic candles, etc.**  
The performance of the filters may be impaired, causing the room to become dirty due to the build-up of dust that is not captured.

### ■ Do not use cosmetics etc., containing silicone\* near the unit.

- \* Hair care products (split ends coating agents, hair mousse, hair treatment agents etc.), cosmetics, antiperspirants, antistatic agents, waterproof sprays, lustering agents, glass cleaners, chemical wiping cloths, wax, etc.
- If an insulator such as silicone adheres to the needle of the streamer unit, the streamer discharge may not be generated.
  - The dust collection filter may become clogged up resulting in reduced air purifying capacity.

### ■ Do not use an ultrasonic humidifier or similar appliance near the unit.

The dust collection filter may become clogged up resulting in reduced air purifying capacity.

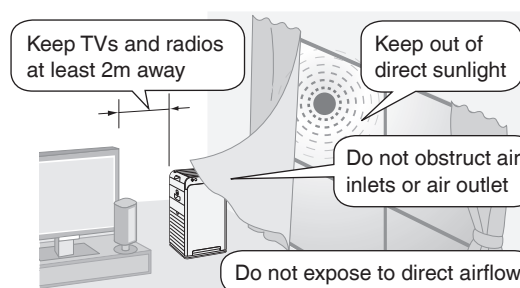

### About streamer discharge and active plasma ions

In some cases the air outlet may emit a slight odour as trace amounts of ozone are generated. However, the amount is negligible and is not harmful to your health.

**This product cannot eliminate the toxic substances in tobacco smoke (carbon monoxide etc.)**

# Preparation Before Operation

## 2 Preparing the remote controller

### 1. Attach the remote controller holder.

- Insert the hook on the remote controller holder into the notch in the back of the unit.

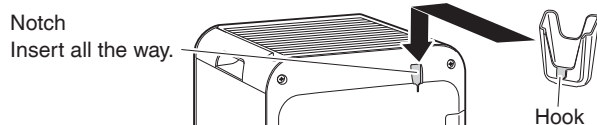

### 2. Pull out the transparent sheet.

- After removing the transparent sheet, the remote controller is ready for use.

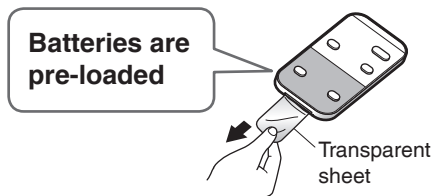

### How to use

- Direct the signal transmitter on the remote controller at the signal receiver on the unit. The unit may fail to receive signals if anything is obstructing the signals, such as a curtain.
- Maximum transmission range is approx. 6m (straight line).

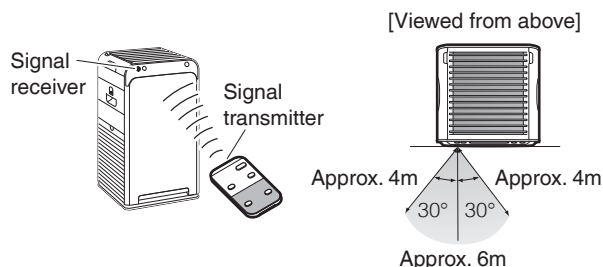

### About the remote controller

- Make sure not to drop or allow water to get into the remote controller. (Malfunction may result)
- Signal reception may be poor in rooms with electronic-starter-type fluorescent lamps (inverter-type fluorescent lamps etc.).
- Do not use near lighting equipment (within 1m). (Decline in the receptivity of the remote controller signal receiver or discolouration may result)

### Replacing the battery

1. Move the catch on the cover at the bottom of the remote controller in the direction of the arrow.
2. Pull out the cover.
3. Replace the battery.
4. Return the cover to its original position.

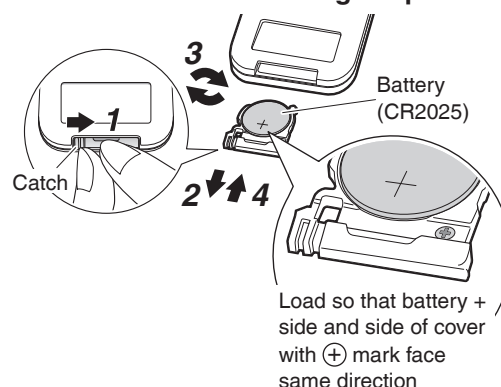

### About the battery

- Keep batteries out of reach of children. In the event that batteries are swallowed, seek the immediate attention of a medical professional.
- To avoid possible injury or damage from battery leakage or rupturing, remove the battery when not using the product for long periods of time.
- If the alkaline solution from batteries should get in the eyes, do not rub the eyes. Instead, immediately flush the eyes with tap water and seek the attention of a medical professional.
- Do not expose batteries to heat or fire. Do not disassemble or modify batteries. The insulation inside the battery may be damaged and result in leakage, heat build-up, or explosion.
- When disposing of the battery insulate the terminal by wrapping it in tape etc. (Heating, rupturing, or fire may result if stored together with other metal objects or batteries) Observe local waste separation rules when disposing of button batteries.
- As a guideline, you should replace the battery once a year. However, the battery should be replaced with a new battery (CR2025) when signal reception weakens.
- Batteries with an expiration date that is close, may require replacement sooner.
- The pre-loaded battery is for initial use of the unit. It may require replacement after less than 1 year.

## 3 Insert the power supply plug into the socket

- The sensitivity of the odour sensor will be determined by odour levels in the first minute (approx.) after the power supply plug is inserted. **Insert the power supply plug when the air is clean (odour-free).**

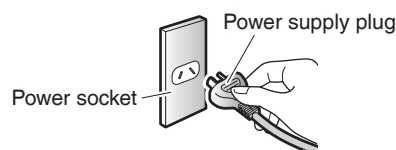

# Operation

## ⚠ WARNING

Do not turn off the unit by unplugging it from the power socket. (Fire or an electric shock may result from heating)

### Operation

#### Remote controller

Operation via remote controller.

#### Unit

Operation via operating/indicator panel on unit.

Detailed settings can be made using the remote controller.

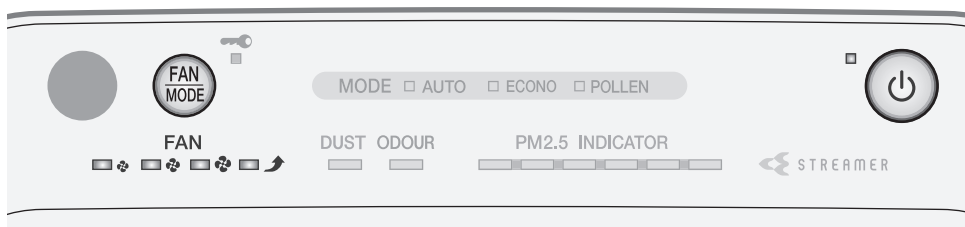
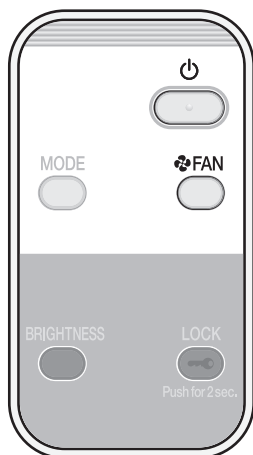

## Using the Air Purifying Operation (turning operation ON/OFF)

Cleans the air in the room.

#### Remote controller

Press .

#### Unit

Press .

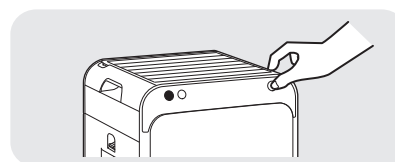

- ON/OFF lamp [green] lights up.
- Press again to turn OFF.

#### Attention

- Do not move the unit, or attach or remove parts to/from the unit while it is in operation. Breakage or malfunctioning may result.

#### Note

- At the time of purchase, the unit is set to Air purifying operation, AUTO FAN MODE with active plasma ion generation set to ON.
- When the unit is unplugged or turned OFF, it will operate with the settings last used the next time it is turned ON.
- Operation settings cannot be changed for about 2 seconds immediately after the power supply plug is inserted.

## Changing the Airflow Rate

Select the desired FAN setting.

: Quiet   : Low   : Standard   : Turbo   \* The size of the symbols varies in accordance with the FAN setting.

#### Remote controller

Press .

- Each press cycles between the FAN lamps [green].



#### Unit

Press .

- Each press cycles between the FAN lamps [green] and MODE lamps [green].

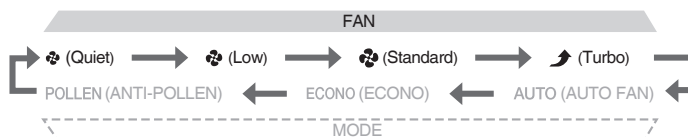

#### About FAN settings

- Quiet**   A gentle breeze is emitted. Recommended for use during sleep hours. To quickly eliminate odours from a room, it is recommended that the FAN setting be set to Standard or above otherwise deodorising capacity is reduced.
- Turbo**   The ambient air is quickly purified using a large airflow. Recommended for use while you are cleaning up a room.

# Useful Functions

## Remote controller

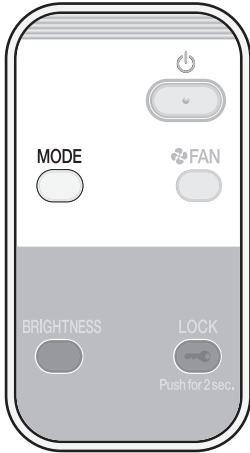

## Unit

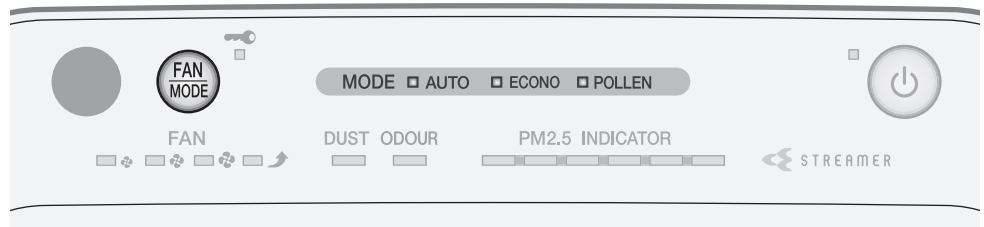

## Operating the Unit in a MODE

Select a MODE specific to your needs.  
Airflow is adjusted automatically when the unit is running in a MODE.

### Remote controller

Press .

- Each press cycles between the MODE lamps [green].



### Unit

Press .

- Each press cycles between the MODE lamps [green] and FAN lamps [green].

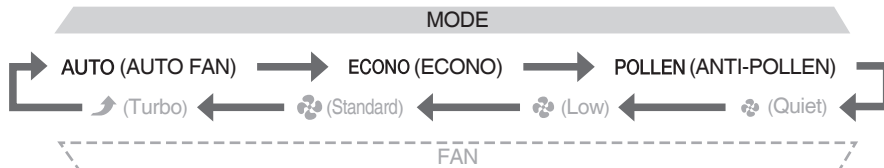

MODE	Usage and Function
AUTO FAN	<p><b>Automatic airflow rate adjustment</b></p> <p>FAN setting (Quiet, Low, Standard, High) is automatically adjusted according to the degree of air impurity. Purifying capacity increases as airflow rate rises.</p> <ul style="list-style-type: none"> <li>Degree of air impurity corresponds to the volume of dust and the intensity of odours in the ambient air.</li> </ul>
ECONO	<p><b>Saving energy</b></p> <p>In Power saving mode within ECONO MODE, the FAN setting automatically switches between Quiet and Low only. Power consumption (*1) and operating sounds are minimised. If the air is clean, after a short while, Monitoring mode automatically activates. Recommended for use during sleep hours.</p> <p>*1 By comparison to AUTO FAN MODE (approx. 10.3Wh), power consumption in ECONO MODE (approx. 6.7Wh) is approx. 3.6Wh lower. Test conditions: operation in 10m<sup>2</sup> area over 1 hour. Assuming 1 cigarette was smoked immediately after the unit was turned on.</p> <div style="display: flex; justify-content: space-between; align-items: flex-start;"> <div data-bbox="331 1106 635 1347" style="border: 1px solid black; padding: 5px; width: 30%;"> <p><b>Power saving mode</b></p> <p>FAN setting switches automatically between Quiet and Low.</p> </div> <div data-bbox="676 1118 903 1340" style="text-align: center; width: 30%;"> <p>If the air is clean, after a short while...</p>  <p>If dust or odours are detected...</p> </div> <div data-bbox="943 1106 1433 1347" style="border: 1px solid black; padding: 5px; width: 30%;"> <p><b>Monitoring mode</b></p> <ul style="list-style-type: none"> <li>The fan starts and stops periodically. Dust and odours are monitored.</li> <li>The following functions are turned off, further reducing power consumption.</li> </ul> <p>Streamer <input type="checkbox"/> OFF</p> <p>Active plasma ion <input type="checkbox"/> OFF</p> </div> </div> <ul style="list-style-type: none"> <li>As the FAN setting is limited to Quiet and Low, air purifying capacity is reduced.</li> <li>As air is not drawn in when the fan has stopped, the dust/PM2.5 sensor, and odour sensor reduce in sensitivity. To prevent this reduction in sensitivity, turn Monitoring mode OFF. <a href="#">▶Page 16</a></li> <li>FAN setting is adjusted automatically. Airflow cannot be adjusted manually.</li> </ul>
ANTI-POLLEN	<p><b>Reducing pollen levels</b></p> <p>A gentle air current is created by switching every 5 minutes between the FAN setting Standard and Low so that pollen can be drawn in and caught before it reaches the floor.</p> <ul style="list-style-type: none"> <li>FAN setting is adjusted automatically. Airflow cannot be adjusted manually.</li> </ul>

# Useful Functions

## Remote controller

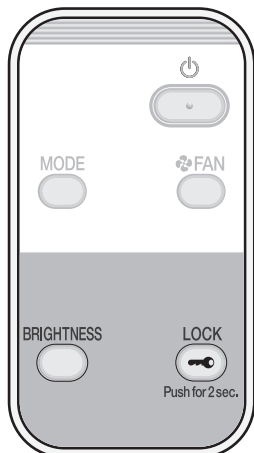

## Unit

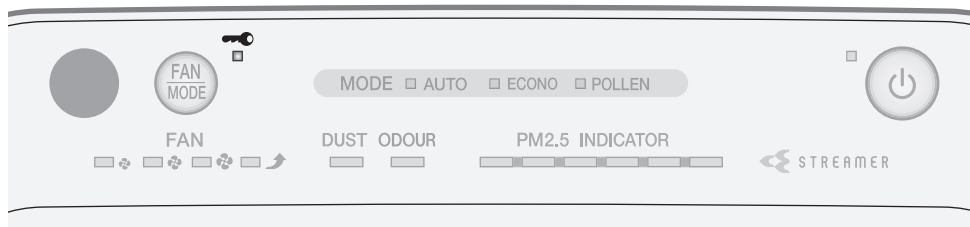

## Using the Child Proof Lock

Button operation is restricted preventing misoperation by small children.

### Remote controller

Hold down  for about 2 seconds.

### Unit

Cannot be set from unit.

- Hold down  for 2 seconds again to turn off child lock.
- When Child proof lock is active, operations will be restricted. When buttons are pressed, only a tone (3 short beeps) will sound, preventing misoperation by small children.

### Note

- If the unit is unplugged when Child proof lock is active, Child proof lock is turned off.
- The Child proof lock lamp [orange] lights up when the function is active.

## Adjusting Indicator Lamp Brightness

Indicator lamp brightness is adjustable.

### Remote controller

Press  .

### Unit

Cannot be set from unit.

- Press to cycle between settings.



### Note

- This function is useful if the lamps bother you during sleep hours etc.
- The ON/OFF lamp does not turn off even if the brightness is set to OFF. This lamp will be set to DIM.
- If any of the below buttons are pressed when brightness is set to OFF, brightness will change to DIM and return to OFF after about 10 seconds.

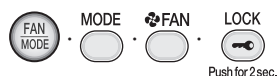

# Advanced Settings

If the hissing sound generated by the streamer discharge or the smell of ozone bother you

\*Setting at time of purchase



## Streamer Output Settings

Regular\*

Low

### Setting procedures **Remote controller**

Hold down  and  for about 3 seconds when the unit is off.

- Each time  and  are held down for about 3 seconds, the setting switches between Regular and Low.

[When the setting is changed to Low]

A short beep sounds and the streamer lamp blinks for about 5 seconds.



[When the setting is changed to Regular]

A short beep sounds and the streamer lamp lights up for about 5 seconds.



### ■ Operation status of streamer

Streamer output setting		Regular	Low
		Regular	Low
FAN	Quiet, Low	ON-OFF*	OFF
	Standard		ON-OFF*
	Turbo	ON	ON
MODE	AUTO FAN, ANTI-POLLEN	ON-OFF*	ON-OFF*
	ECONO		OFF

\*The streamer operation status ON-OFF means that the streamer turns ON and OFF automatically depending on the degree of air impurity and FAN setting.

- The streamer lamp turns off when streamer operation is OFF.

### Note

- It is recommended that the streamer be set to Regular as deodorising capacity is reduced when set to Low.
- Settings are remembered even if the unit is unplugged.

When you want to turn off active plasma ion output

\*Setting at time of purchase



## Active Plasma Ion Output Settings

ON\*

OFF

### Setting procedures **Remote controller**

Hold down  and  for about 3 seconds when the unit is off.

- Each time  and  are held down for about 3 seconds, the setting switches between ON and OFF.

[When the setting is changed to OFF]

A short beep sounds and the dust lamp and odour sensor lamp blink green for about 5 seconds.



[When the setting is changed to ON]

A short beep sounds and the dust lamp and odour sensor lamp light up green for about 5 seconds.



### Note

- Settings are remembered even if the unit is unplugged.
- If set to OFF, active plasma ion discharge stops, however, dust and odour removal continues.
- If the smell of ozone bothers you, set active plasma ion output to OFF.**
- If the smell of ozone continues to bother you, even after output has been set to OFF, set streamer output to Low.

# Advanced Settings



When the sensitivity of the dust/PM2.5 sensor does not meet your preferences

\*Setting at time of purchase

## Setting Dust/PM2.5 Sensor Sensitivity

High Normal\* Low

Setting procedures **Remote controller** **Unit**

**1. Hold down**  **on the unit for about 5 seconds and when a short beep sounds, press**  **on the remote controller while pressing**  **on the unit.**

- This setting change can be performed when the unit is on or off.

**2. Release both buttons when a short beep sounds.**

- One of the FAN lamps ( (Low),  (Standard),  (Turbo)) will blink for about 5 seconds and then the lamp corresponding to the currently set sensitivity will light up.

**3. Press**  **on the unit to change the sensitivity setting.**

- Each press cycles between the FAN lamps allowing you to change the sensitivity.

To set sensitivity **High**

▶ Select the FAN lamp  (Turbo).

To set sensitivity **Low**

▶ Select the FAN lamp  (Low).

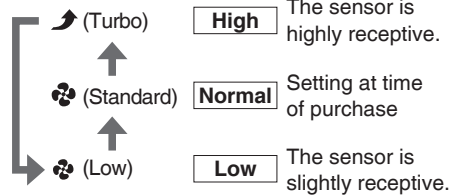

**High** The sensor is highly receptive.

**Normal** Setting at time of purchase

**Low** The sensor is slightly receptive.

- Setting is indicated using the FAN lamps. If the FAN lamp does not change, unplug the unit, wait at least 5 seconds, then reinsert the power supply plug and repeat the above procedure from the beginning.

**4. Press**  **on the remote controller after selecting the new setting.**

- A short beep sounds and the new setting will blink. Unplug the unit while the lamp is blinking, wait at least 5 seconds, and then reinsert the power supply plug. Setting is now complete.
- If this procedure is not performed, the unit will not return to regular operation mode.

### Note

- Settings are remembered even if the unit is unplugged.





If you wish to turn Monitoring mode (within ECONO MODE) OFF

\*Setting at time of purchase

## Settings of Modes within ECONO MODE

Monitoring ON*	Monitoring OFF
----------------	----------------

Setting procedures **Remote controller** **Unit**

**1. Hold down**  **on the unit for about 5 seconds and when a short beep sounds, press**  **on the remote controller while pressing**  **on the unit.**

- This setting change can be performed when the unit is on or off.

**2. Release both buttons when a short beep sounds.**

- The FAN lamp  (Quiet) and ECONO MODE lamp will light up after blinking for about 5 seconds. The ECONO MODE lamp will light up or blink depending on the ON/OFF status of Monitoring mode.

**3. Press**  **on the unit to change the setting.**

- Each press turns the ECONO MODE lamp ON or OFF. (The FAN lamp  (Quiet) will remain lit up.)

To turn Monitoring mode **ON**  
▶ Turn on the ECONO MODE lamp.

 ECONO  Setting at time of purchase

To turn Monitoring mode **OFF**  
▶ Turn off the ECONO MODE lamp.

 ECONO 

- Setting is indicated using the ECONO MODE lamp. If the ECONO MODE lamp does not change, unplug the unit, wait at least 5 seconds, then reinsert the power supply plug and repeat the above procedure.

**4. Press**  **on the remote controller after making the new setting.**

- A short beep sounds and the FAN lamp  (Quiet) will blink. When Monitoring mode is turned ON, the ECONO MODE lamp also blinks. Unplug the unit while the lamp is blinking, wait at least 5 seconds, and then reinsert the power supply plug. Setting is now complete.
- If this procedure is not performed, the unit will not return to regular operation mode.

### Note

- Settings are remembered even if the unit is unplugged.

Before cleaning and maintenance work, make sure to unplug the unit. (An electric shock or injury may result)

# Maintenance

## Outflow grille

When dirt becomes an issue

**Wipe**

**Wash/Rinse**

- Wipe up dirt with a soft damp cloth and rinse with water.
- Do not use a hard brush etc. (Breakage may result)
- When dirt buildup is severe, leave the part soaking in lukewarm or room temperature water mixed with kitchen-use neutral detergent, thoroughly rinse off the detergent, and leave the part in shade to dry off.

**Removing**

- Place a finger into the notch in the top of the unit and lift.

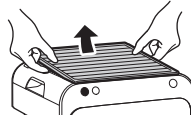

**Attaching**

- Pay attention to orientation and attach securely.

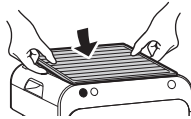

## Unit

When dirt becomes an issue

**Wipe**

- Wipe up dirt with a soft damp cloth.
- When dirt buildup is severe, wet a cloth with kitchen-use neutral detergent and wipe up the dirt.
- Do not use a hard brush etc. (Damage may result)

## Pre-filter (Front/Left-side/Right-side)

About every 2 weeks

**Vacuum clean**

**Wash/Rinse**

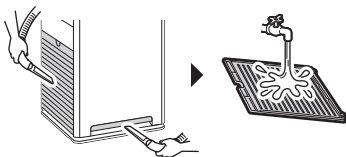

- After removing any dust using a vacuum cleaner, remove and wash the filter with water and then leave it in shade to dry off.
- Use a soft brush when cleaning the spaces in the grid.

**Attention**

- Do not use a cotton bud or hard brush etc. (Partial breakage of the filter may result)
- Do not apply heavy force. (Partial breakage/damage of the filter may result)
- When dirt buildup is severe, leave the part soaking in lukewarm or room temperature water mixed with kitchen-use neutral detergent, thoroughly rinse off the detergent and leave the part in shade to dry off.

**Removing**

- Grip the indent in the pre-filter and pull.



- ① Grip either end of the pre-filter resting your thumb against the unit.

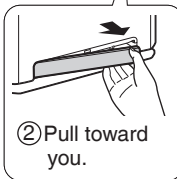

- ② Pull toward you.

**Attaching**

Insert the hooks (2 places) into the unit and press until a catching sound is heard.

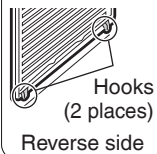

Hooks (2 places)  
Reverse side

Insert the hook (1 place) into the unit. Push both ends until securely attached.

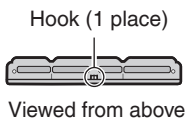

Hook (1 place)  
Viewed from above

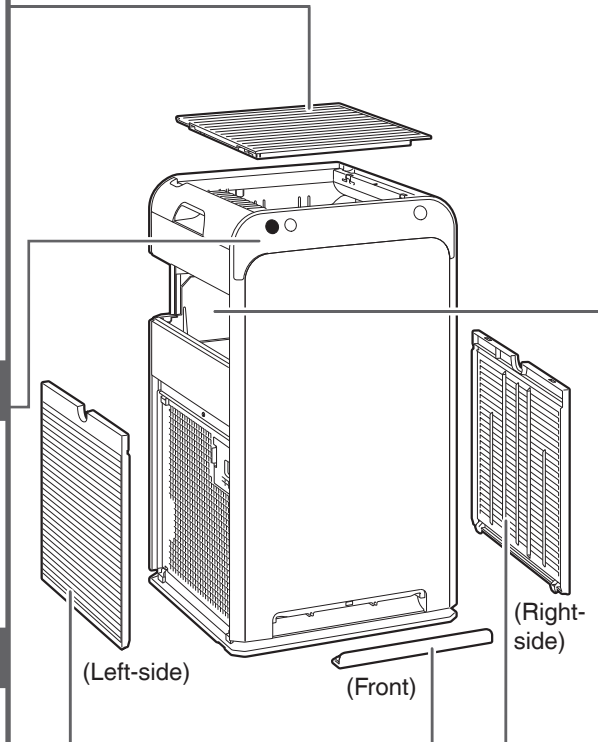

## Dust/PM2.5 sensor

When dust has built up

**Vacuum clean**

- ① Remove the pre-filter (left-side).
- ② Vacuum off any dust that has adhered to the air intake for dust/PM2.5 sensor using the vacuum cleaner crevice tool or similar.

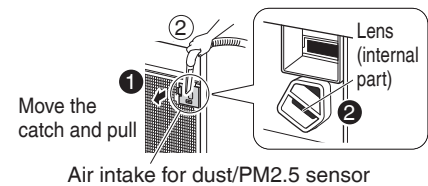

Move the catch and pull

Air intake for dust/PM2.5 sensor

About every 3 months **Wipe**

- ① Remove the pre-filter (left-side) and the cover for the air intake for dust/PM2.5 sensor.
- ② Wipe the lens with a dry cotton bud.

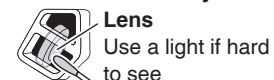

**Lens**

Use a light if hard to see

Use the vacuum cleaner crevice tool or similar to remove any dust that has built up around the lens.

- ③ Place the cover on securely. (Malfunction may result if the cover is off)

## ⚠ WARNING

- Do not use petrol, benzene, thinner, polishing compound, paraffin, alcohol, etc. (An electric shock, fire, or cracking may result)
- Do not wash the main body of the unit with water. (An electric shock, fire, or malfunctioning/breakage may result)

### Deodorising filter unit

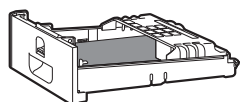

#### When concerned about odours or dirt

**Vacuum clean**

**Do not use water**

- Remove from the unit together with the frame and remove dust using a vacuum cleaner.
- **If odour becomes an issue, leave the part in a shaded, breezy area. (about 1 day)**
- Do not scrub the surface.
- Do not use water when cleaning. (If water is used, the part will lose its shape and become unusable.) ▶Page 22

**Do not detach the deodorising filter from frame**

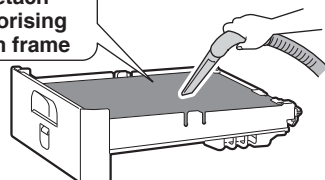

#### Removing

Hold the lever and grip of the deodorising filter unit and remove.

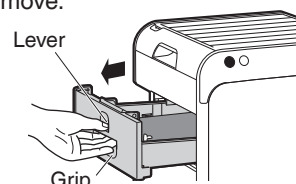

#### Attaching

Fully insert the deodorising filter unit.

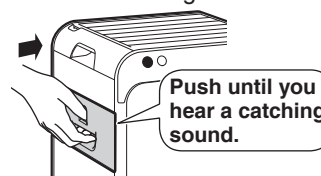

- If the deodorising filter unit is removed or incorrectly installed, the odour sensor lamp will blink.

### Dust collection filter

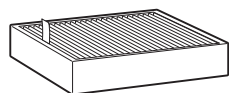

#### About every 10 years **Replace**

**Do not use water**

**Do not vacuum clean**

- Do not use a vacuum cleaner or use water when cleaning. (If the filter is damaged or holes are opened etc., dust will pass through the filter and capacity for dust collection will be reduced.)

#### About part replacement timing

- Replacement timing depends on usage patterns and the location of the unit. If the unit is used daily in a home where 5 cigarettes are smoked a day, the filter should be replaced about every 10 years. (Calculation based on testing method of Japan Electrical Manufacturers Association JEM1467 standard.) If the impurity content of the ambient air is high, the filter will need more frequent replacement. If the filter is failing to perform, it is time to replace it.

#### About purchasing and disposal

- Refer to "Separately Sold Parts". ▶Page 20

#### Removing

- ① Remove the deodorising filter unit.
- ② Pull the tag upward.
- ③ Hold the lower part of the dust collection filter and lift it out.

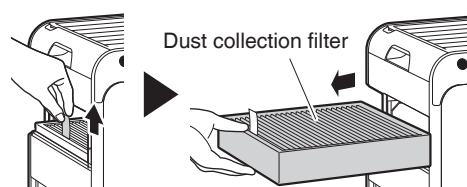

#### Attaching

- ① Install the new dust collection filter, being careful of the orientation.

Side with tag and markings should face outward and arrow should point up



- ② Attach the deodorising filter unit.

### Attention

- Make sure that the dust collection filter and deodorising filter unit are attached to the unit when the unit is operating. If these parts are not attached when the unit is operated, breakage/malfunctioning may result.
- Follow the advice below to prevent discolouration or deformation.
  - If detergent was used, make sure to wipe it up thoroughly so none remains.
  - If hot water is used, make sure that it is 40°C or less.
  - Do not leave parts to dry in direct sunlight.
  - Do not dry parts using a dryer.
  - Do not apply fire to parts.
- If using a vacuum cleaner, make sure to not apply force to or knock the part. (Damage may result)

Before cleaning and maintenance work, make sure to unplug the unit. (An electric shock or injury may result)

# Maintenance

## Replacing the Streamer Unit

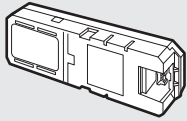

### If the streamer lamp blinks

The streamer unit will not need to be replaced. However, depending on where the unit is used (places where oils are present, or dust and humidity is abundant, or sprays and chemical agents are used, etc.) replacement may become necessary. [▶Page 21](#)

Contact the place of purchase.

**1. Remove the pre-filter on the left side from the back of the unit.** [▶Page 17](#)

**2. Flip up the protective covers and remove the streamer unit cover.**

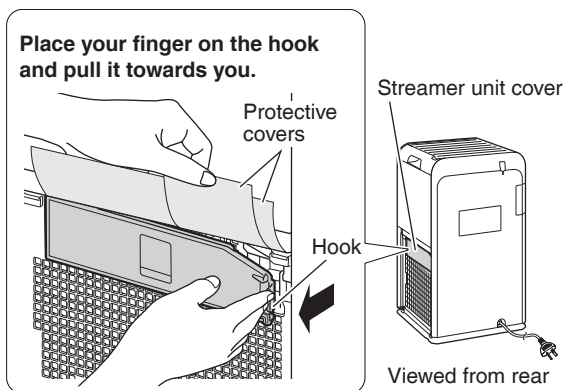

**3. Remove the streamer unit.**

① Remove the streamer unit connector.

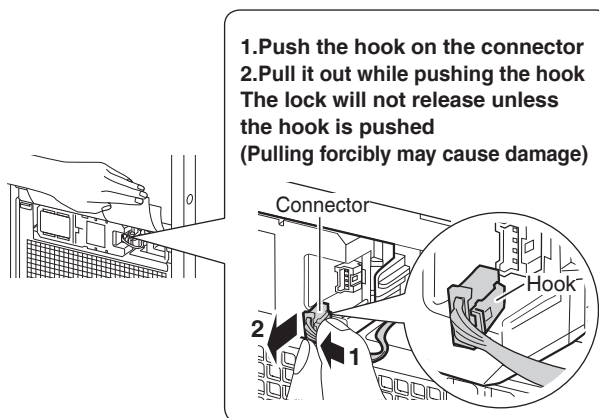

② Push in the left side of the streamer unit so the right side comes out.

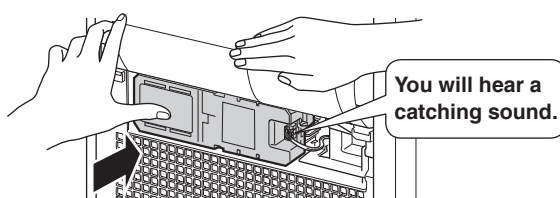

③ Remove the streamer unit.

**4. Attach the new streamer unit.**

① Insert the streamer unit from the left side, and push until the hook makes a catching sound.

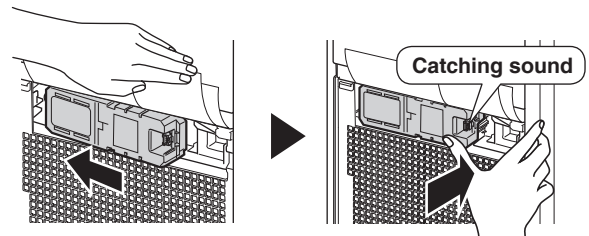

② Make sure the hook is facing to the right, and insert the connector as deeply as it will go.

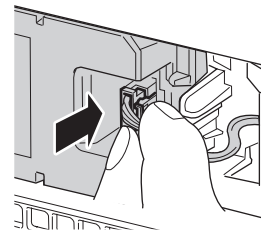

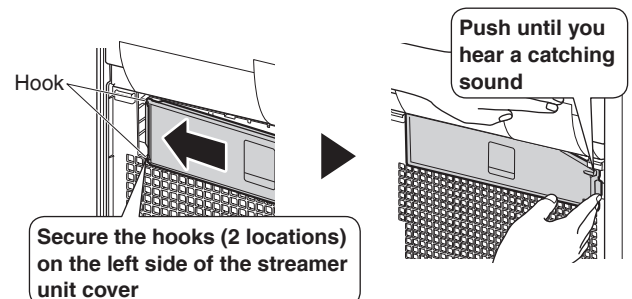

**5. Attach the streamer unit cover.**



- Ensure you don't trap the connector cord.
- If the streamer unit cover is not properly attached the safety switch will engage, and the unit cannot operate.

**6. Attach the pre-filter.** [▶Page 17](#)

**7. Insert the power supply plug while pressing  on the unit, and wait until a short beep sounds.**

- The streamer lamp will turn off.
- If you release  and attempt operation before the short beep sounds, the streamer lamp will blink again.
- If you perform this step and the streamer lamp still blinks, please check that the connector is properly inserted.

## Separately Sold Parts

Contact the place of purchase.

### Replacement part

**Dust collection filter** (1 piece)

Model: KAFP080B4E

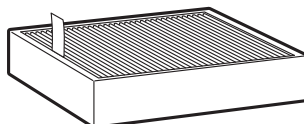

- Replace about every 10 years.
  - Catches dust and pollen.
- 
- Failure to clean parts properly could result in:
    - Reduced air purifying capacity.
    - Reduced deodorising capacity.
    - Emission of odours.
  - Observe local waste separation rules when disposing of the dust collection filter (made of polyester and polypropylene).

## When Not Using the Unit for Long Time Periods





- 1. Remove the power supply plug.**
- 2. Clean the parts.** [▶Page 17, 18](#)
  - In particular, components cleaned with water should be completely dry. (Mould may result from remaining moisture)
- 3. Cover the air outlet and other openings with a plastic bag or similar to prevent dust entry, and store the unit upright in a dry place.**  
(Malfunctioning/breakage may result from storing the unit upside down or on its side)

# About the Indicator Lamps

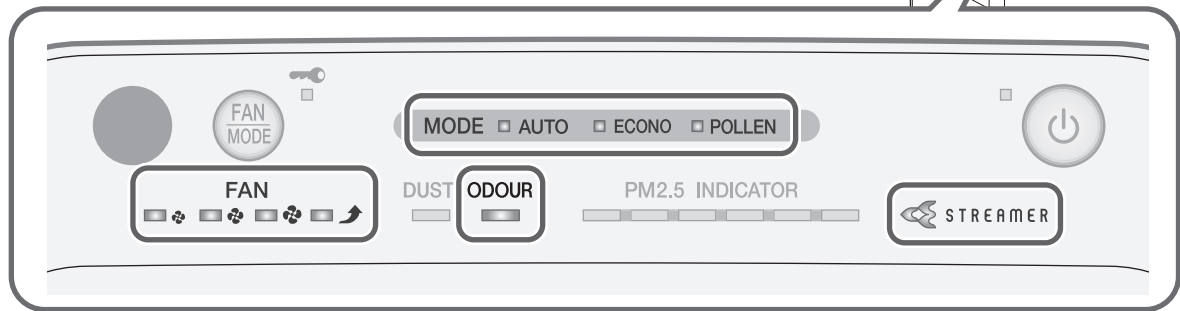
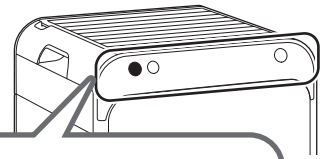
## Operating/Indicator panel

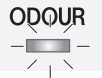
Check the indicator lamps and respond as indicated below.



Indicator lamp	Cause/Solution	
<b>Odour sensor lamp is blinking.</b> 	This lamp blinks if the deodorising filter unit has become detached or is not attached properly. → Attach the deodorising filter unit properly. (▶Page 18)	
<b>Streamer sensor lamp is blinking.</b> 	It is time to replace the streamer unit. (▶Page 19)	
<b>All 3 MODE lamps are blinking simultaneously.</b> 	An electrical component is faulty. → Contact the place of purchase.	
<b>AUTO FAN MODE lamp is blinking.</b> 	An electrical component is faulty. → Contact the place of purchase.	
<b>All 4 FAN lamps are blinking simultaneously.</b> 	Are the pre-filter, outflow grille, and dust collection filter attached? These lamps may blink if the unit is operated without a part attached.	<ul style="list-style-type: none"> <li>■ <b>If all parts are attached</b> An electrical component is faulty. → Contact the place of purchase.</li> <li>■ <b>If one or more components are not attached</b> Remove the power supply plug, reattach the parts and then turn the unit on again.</li> </ul>
	Is there a buildup of dust on the pre-filter?	<ul style="list-style-type: none"> <li>■ <b>If there is no dust buildup</b> An electrical component is faulty. → Contact the place of purchase.</li> <li>■ <b>If there is a dust buildup</b> Remove the power supply plug, clean the pre-filter and then turn the unit on again. (▶Page 17)</li> </ul>
	Is the air outlet blocked?	<ul style="list-style-type: none"> <li>■ <b>If the air outlet is not blocked</b> An electrical component is faulty. → Contact the place of purchase.</li> <li>■ <b>If the air outlet is blocked</b> Remove any obstacles blocking the air outlet and then turn the unit on again.</li> </ul>
	These lamps may blink if there is a sudden drop in voltage.	

# FAQs

Please check the following before contacting us.

**Q: The dust/PM2.5 sensor seems to have poor sensitivity...**

**A:** Perform periodic cleaning of the dust/PM2.5 sensor as dirt on its lens can lead to poor sensitivity. [▶Page 17](#)  
 In addition, the response time of the dust/PM2.5 sensor varies depending on room size. Make adjustments in accordance with the procedure for setting dust/PM2.5 sensor sensitivity. [▶Page 15](#)  
 The responsiveness of the dust/PM2.5 sensor may be poor during FAN setting "Turbo" or when airflow is high in AUTO FAN MODE.  
 The strong airflow causes dust to be drawn into the air inlet before it can be detected by the dust/PM2.5 sensor. This is normal (not a malfunction).

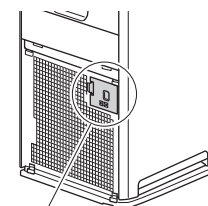

Dust/PM2.5 sensor

**Q: Can the dust collection filter be cleaned?**

**A: No. Do not attempt to clean it with a vacuum cleaner or water.**  
 (Reduced performance of the dust collection filter may result)  
 Replace it if dirt buildup is severe.

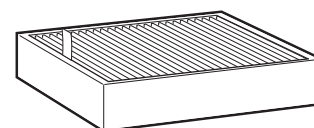

**Q: The dust collection filter easily turns black...**

**A:** The blackening does not affect dust collection performance. However, it can be replaced if it is an issue.

**Q: Can the deodorising filter be cleaned with water? Or should it be replaced?**

**A: It cannot be cleaned with water.**  
 (If water is used, the part will lose its shape and become unusable.)  
 If you have inadvertently washed it with water, consult the place of purchase.  
 Remove the deodorising filter unit from the main body and vacuum off dust with a vacuum cleaner.  
 It is not necessary to replace the filter.  
**If odour becomes an issue, leave the part in a shaded, breezy area. (about 1 day)** [▶Page 18](#)

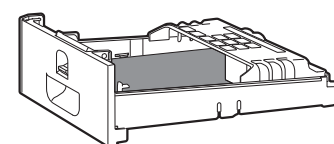

# Troubleshooting

■ **Before making an inquiry or a request for repair, please check the following.**

If the problem persists, contact the place of purchase.

■ **In the event of malfunction during operation**

If the indicator lamps light up abnormally, or become inoperable, due to a lightning strike etc., remove the power supply plug, wait at least 5 seconds then reinsert the power supply plug and turn the unit on again.



**Not a problem**





This case is not a problem.





**Check**

Please check again before requesting repairs.

■ **Unit does not respond**

Phenomenon	Check points
No response even if  on the remote controller is pressed	<ul style="list-style-type: none"> <li> • <b>Has the battery run out?</b> → Replace the battery. <a href="#">▶Page 9</a></li> <li>• <b>Is a button on a remote controller for a TV, VCR, or other appliance, stuck pressed down?</b> → If a button on another remote controller is stuck pressed down because it is pressed against a remote controller rack etc., it may interfere with reception.</li> <li>• <b>Is there a device in the room that redirects remote controller signals?</b> → Some appliances such as TV speakers are equipped with such devices. If there is such a device in the room, the signals it emits may interfere with signals from the remote controller, preventing reception.</li> </ul>
	<ul style="list-style-type: none"> <li> • To protect the system, the unit may stop operating after sudden large voltage fluctuations. If operating at the time, operation will resume automatically once voltage returns to normal. Voltage range protection: 180V-264V</li> </ul>
Unit will not operate	<ul style="list-style-type: none"> <li> • <b>Is the streamer unit cover attached?</b> <b>If it is not attached the safety switch will engage, and the unit cannot operate.</b> → Install the streamer unit cover properly and attempt operation again. <a href="#">▶Page 19</a></li> </ul>













■ **Sounds can be heard**

Phenomenon	Check points
Hissing sound during operation	<ul style="list-style-type: none"> <li> • While the streamer is operating, the streamer unit will emit a hissing sound when conducting streamer discharge. Depending on usage, the sound may fall in volume or change to a crackling, whirring, or guzzling sound. However, this is normal. If the sounds are an issue, try moving the unit to a different location. <a href="#">▶Page 14</a></li> </ul>
Whistling and fluttering sound during operation	<ul style="list-style-type: none"> <li> • <b>Is there a buildup of dust on the pre-filter?</b> → Clean this part. <a href="#">▶Page 17</a></li> <li>• <b>Is the dust collection filter clogged up?</b> → Depending on usage conditions, the dust collection filter may become clogged up, shortening its service life. <a href="#">▶Page 8</a> Replace the dust collection filter. <a href="#">▶Page 18</a></li> </ul>
Operating sound is loud	<ul style="list-style-type: none"> <li> • <b>Is the dust collection filter attached properly?</b> → If it is not properly attached, operating sounds may become louder. <a href="#">▶Page 18</a></li> </ul>

■ **Indicator lamps**



Phenomenon	Check points
Indicator lamps do not light up  Indicator lamps turn off about 10 seconds after the unit is turned on	<ul style="list-style-type: none"> <li> • <b>Is indicator lamp brightness set to OFF?</b> → If indicator lamp brightness is set to OFF, all lamps except the ON/OFF lamp will remain off. → If indicator lamp brightness is set to OFF, after the unit is turned on, the brightness of the indicator lamps will be DIM for about 10 seconds and then turn OFF. <a href="#">▶Page 13</a></li> </ul>









Phenomenon	Check points
<p>All the FAN lamps ( , , , and ) blink together</p>	<p> • <b>Are the pre-filter, outflow grille, and dust collection filter attached?</b>  <b>These lamps may blink if the unit is operated without a part attached.</b>                      [If one or more parts are not attached]                      → Remove the power supply plug, reattach the parts and then turn the unit on again.                      [If all parts are attached]                      An electrical component is faulty.                      → Contact the place of purchase.</p> <p>• <b>Is there a buildup of dust on the pre-filter?</b>                      [If there is a dust buildup] <a href="#">▶Page 17</a>                      → Remove the power supply plug, clean the pre-filter and then turn the unit on again.                      [If there is no dust buildup]                      An electrical component is faulty.                      → Contact the place of purchase.</p> <p>• <b>Is the air outlet blocked?</b>                      [If the air outlet is blocked]                      → Remove any obstacles blocking the air outlet and then turn the unit on again.                      [If the air outlet is not blocked]                      An electrical component is faulty.                      → Contact the place of purchase.</p> <p> • These lamps may blink if there is a sudden drop in voltage.                      The lamps will return to their previous condition once voltage returns to normal.                      Voltage range protection: 180V-264V</p>
<p>The dust sensor lamp remains orange or red</p>	<p> • <b>Is there a buildup of dust in or around the air intake for the dust/PM2.5 sensor?</b>                      → Vacuum off any dust from the air intake using a cleaner. <a href="#">▶Page 17</a></p> <p>• <b>Is the cover detached from the air intake for the dust/PM2.5 sensor?</b>                      → Securely attach the cover. <a href="#">▶Page 17</a></p> <p>• <b>Is the lens for the dust/PM2.5 sensor dirty?</b>                      → Wipe off dirt from the lens using a dry cotton bud or similar. <a href="#">▶Page 17</a></p> <p>• <b>Is the pre-filter dirty?</b> <a href="#">▶Page 17</a>                      → Clean these parts.</p> <p>After cleaning, the unit will return to normal operation a short while after being turned on.</p>
<p>The PM2.5 INDICATOR lamp remain red, purple or brown.</p>	
<p>There is an odour but the odour sensor lamp remains green</p>	<p> • <b>Did an odour emerge around the time you inserted the power supply plug?</b>                      → The sensitivity of the odour sensor will be determined by odour levels in the first minute (approx.) after the power supply plug is inserted. <a href="#">▶Page 6</a></p> <p>When the air is clean (i.e. there are no odours), remove the power supply plug. Wait at least 5 seconds then reinsert the power supply plug and turn the unit on again. This process adjusts the reference odour level that determines the sensitivity of the odour sensor.</p>
<p>Sometimes the streamer lamp does not light up</p>	<p> • The streamer may cease operating depending on the degree of air impurity.                      The streamer lamp turns off when the streamer ceases operating.</p>
	<p> • <b>Is streamer output set to Low?</b>                      → When set to Low, the streamer operates for a shorter time compared to when it is set to Regular. <a href="#">▶Page 14</a></p> <p>• <b>Is the unit operating in ECONO MODE?</b>                      → The streamer lamp does not light up when the unit is in Monitoring mode. <a href="#">▶Page 12</a></p>
<p>The streamer lamp blinks even though the streamer unit has been replaced</p>	<p> • <b>After replacement, was the power supply plug inserted while pressing  on the unit?</b> <a href="#">▶Page 19</a></p> <p>• <b>Is the streamer unit's connector properly installed?</b>                      [In case of improper installation]                      → Pull out the power supply plug, reattach the connector, and attempt operation again. <a href="#">▶Page 19</a></p> <p>[In case of proper installation]                      An electrical component is faulty.                      → Contact the place of purchase.</p>
<p>The odour sensor lamp blinks</p>	<p> • <b>Is the deodorising filter unit attached?</b>                      → Attach the deodorising filter unit. <a href="#">▶Page 18</a></p>

# Troubleshooting

## ■ Air purifying function

Phenomenon	Check points
Air purifying capacity is reduced	<ul style="list-style-type: none"> <li> • <b>Is the unit positioned in a place where airflow cannot reach or surrounded by obstacles?</b> → Choose a position that is obstacle-free and from where airflow can reach all areas of the room.</li> <li>• <b>Is the pre-filter or dust collection filter dirty?</b> → Clean these parts. <a href="#">▶Page 17, 18</a></li> </ul>
The air outlet is emitting an odour	<ul style="list-style-type: none"> <li> • <b>Is the deodorising filter dirty?</b> → Clean these parts. <a href="#">▶Page 18</a></li> <li>• In some cases the air outlet may emit a slight odour as trace amounts of ozone are generated. However, the amount is negligible and is not harmful to your health.</li> <li>• <b>Is the room filled with odours due to cooking or several people smoking together etc?</b> → The odour will gradually fade as the unit operates.</li> <li>• <b>Have you moved the unit from another room?</b> → The unit may emit the odour of the room in which it was used previously. Let the unit run a while longer.</li> <li>• <b>Is there anything in the room that is giving off an odour continuously?</b> (Paint, new furniture, wallpaper, sprays, cosmetics, chemicals) → As continuously emitted odours cannot be completely eliminated, you should ventilate the room at the same time or run the unit in a well-ventilated room for a short while.</li> </ul>
No air is being emitted	<ul style="list-style-type: none"> <li> • <b>Is the air outlet or an air inlet blocked?</b> <b>If they are not blocked, the fan motor is faulty.</b> → Contact the place of purchase.</li> </ul>

## ■ Other

Phenomenon	Check points
The fan stops midway through unit operation	<ul style="list-style-type: none"> <li> • When the unit switches to Monitoring mode during operation in ECONO MODE, the fan turns on and off repeatedly. <a href="#">▶Page 12</a></li> </ul>
	<ul style="list-style-type: none"> <li> • <b>Are the pre-filter, outflow grille, and dust collection filter attached before the unit is operated?</b> <b>The fan is configured to stop in order to protect electrical components if a part is not properly attached.</b> → If a part is not attached, unplug the unit and attach all parts before turning the unit on again.</li> </ul>
The sound of streamer discharge can no longer be heard	<ul style="list-style-type: none"> <li> • The streamer may cease operating depending on the degree of air impurity. <a href="#">▶Page 14</a></li> </ul>
	<ul style="list-style-type: none"> <li> • <b>Is streamer output set to Low?</b> <a href="#">▶Page 14</a></li> </ul>
There is interference on our TV screen	<ul style="list-style-type: none"> <li> • <b>Is the TV or radio positioned within 2m of the unit, or is an indoor antenna positioned near the unit?</b></li> <li>• <b>Are the power supply cord or antenna cable of the TV or radio routed near the unit?</b> → Keep the unit as far as possible from the TV, radio, or antenna.</li> </ul>
Just inserting the power plug causes operation to start	<ul style="list-style-type: none"> <li> • <b>Did you disconnect the power plug during a power failure, or when a sudden voltage fluctuation occurred, to move the unit or disconnect the power plug during the last operation?</b> → The auto-restart function automatically resumes operation.</li> </ul>

# Specifications

Model name	MC55YPVM			
Power supply	Single phase 50Hz 220-240V / 60Hz 220-230V			
Operation mode	Air Purifying			
	Turbo	Standard	Low	Quiet
Power consumption (W)	37	15	10	8
Operating sound (dB)	53	39	29	19
Airflow rate (m <sup>3</sup> /h)	330	192	120	66
Coverage area (m <sup>2</sup> )	41			*1
	82			*2
External dimensions (mm)	500(H)× 270(W)× 270(D)			
Weight (kg)	6.8			
Power supply cord length (m)	1.8			

- These specification values are applicable to both 50Hz 220–240V and 60Hz 220–230V.
- Even when the power is off, approx. 1W of power is consumed to run the microcomputer.

\*1.Coverage area was calculated in accordance with JEM1467. (when FAN setting is "Turbo")

\*2.Coverage area was calculated in accordance with NRCC-54013 standard using cigarette smoke CADR that was tested according to JEM1467. (when FAN setting is "Turbo")

***DAIKIN INDUSTRIES, LTD.***

Head office:

Umeda Center Bldg., 2-4-12, Nakazaki-Nishi,  
Kita-ku, Osaka, 530-8323 Japan

Tokyo office:

JR Shinagawa East Bldg., 2-18-1, Konan,  
Minato-ku, Tokyo, 108-0075 Japan  
<http://www.daikin.com>

For manufacturing use only

3P629480-15 F